

Three Phase Rectifier Bridge Module

V_{RRM} 1200 to 2200V
 I_D 100 Amp



Features

- Very low forward voltage drop
- High surge current capability

Applications

- Inverter for AC or DC motor control
- Current stabilized power supply
- Switching power supply

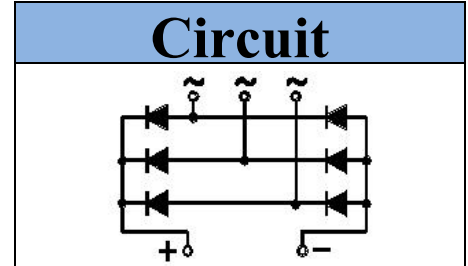

Module Type

Type	V_{RRM}	V_{RSM}
MDS100-12	1200V	1300V
MDS100-16	1600V	1700V
MDS100-18	1800V	1900V
MDS100-20	2000V	2100V
MDS100-22	2200V	2300V

■ Maximum Ratings

Symbol	Item	Conditions	Values	Unit
I_D	Output Current	Three Phase, Full Wave $T_c = 100^\circ\text{C}$	100	A
I_{FSM}	Surge Forward Current	$T_j = 25^\circ\text{C}$, $t = 50\text{Hz}(10\text{ms})$, $V_R = 0\text{V}$	1400	A
I^2t	Circuit Fusing Consideration	$t = 10\text{ms}$ $T_j = 25^\circ\text{C}$	9800	A^2s
V_{ISO}	Isolation Breakdown Voltage	AC 50Hz/60Hz; R.M.S; 1min	2500	V
T_j	Operating Junction Temperature		-40 to +150	$^\circ\text{C}$
T_{stg}	Storage Temperature		-40 to +125	$^\circ\text{C}$
M_t	Mounting Torque	To Heatsink(M5)	$3 \pm 15\%$	N·m
M_s		To Heatsink(M6)	$5 \pm 15\%$	
Weight	Module (Approximately)		180	g

■ Thermal Characteristics

Symbol	Item	Conditions	Values	Unit
$R_{th(j-c)}$	Thermal Impedance, Max	Junction to Case(Per Module)	0.28	$^\circ\text{C}/\text{W}$
		Junction to Case(Per Diode)	1.68	$^\circ\text{C}/\text{W}$
$R_{th(c-s)}$	Thermal Impedance, Max	Case to Heat Sink	0.07	$^\circ\text{C}/\text{W}$

■ Electrical Characteristics

Symbol	Item	Conditions	Values			Unit
			Min.	Typ.	Max.	
V_{FM}	Forward Voltage Drop, Max	$T_j = 25^\circ\text{C}$ $I_F = 100\text{A}$	—	—	1.20	V
I_{RRM}	Repetitive Peak Reverse Current, Max	$T_j = 25^\circ\text{C}$ $V_R = V_{RRM}$	—	—	0.1	mA
		$T_j = 150^\circ\text{C}$ $V_R = V_{RRM}$	—	—	5	
V_{T0}	Threshold Voltage, for power loss calculation only	$T_j = 125^\circ\text{C}$	0.70			V
r_T	Slope Resistance, for power loss calculation only	$T_j = 125^\circ\text{C}$	2.0			m Ω

Performance Curves

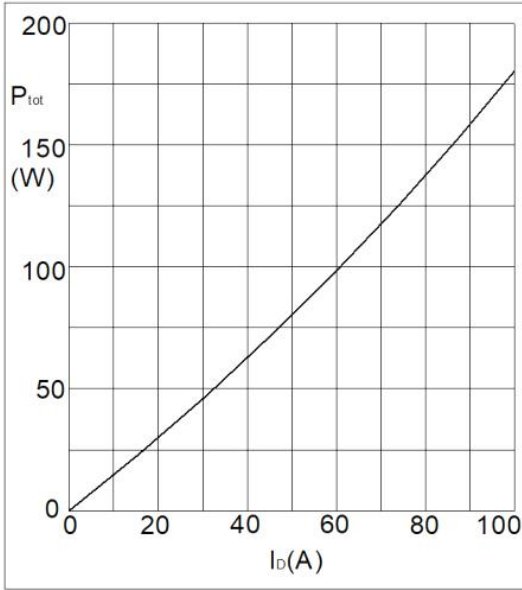

Fig1. Power Dissipation

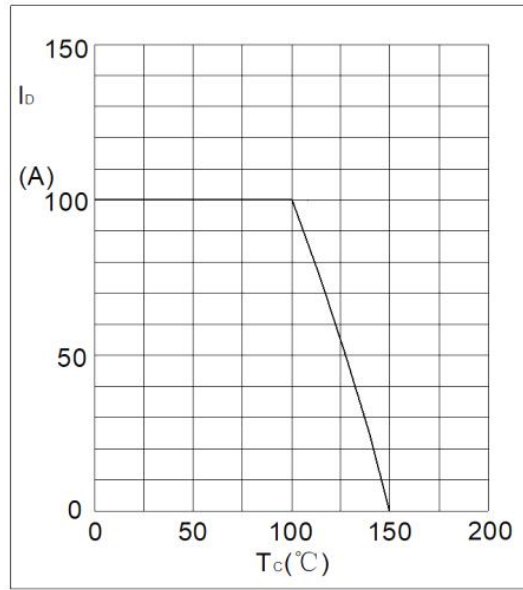

Fig2. Forward Current Derating Curve

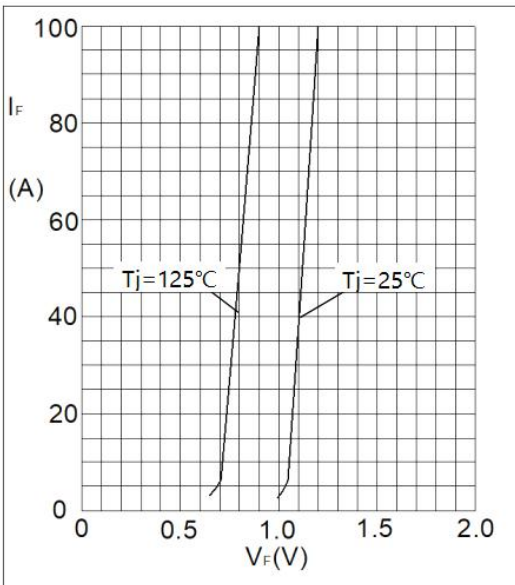

Fig3. Forward Characteristics

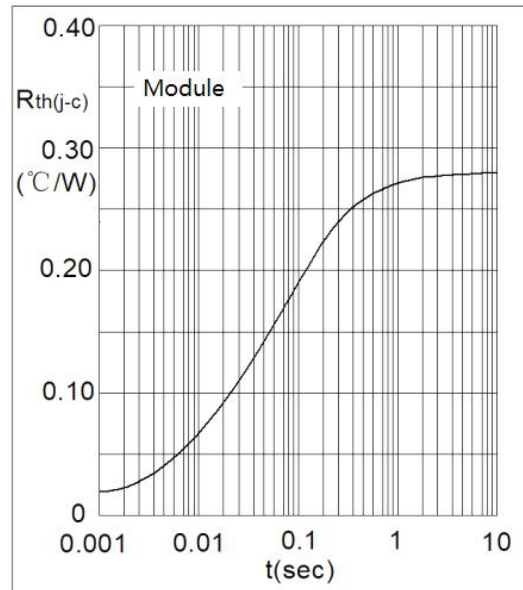

Fig4. Transient Thermal impedance

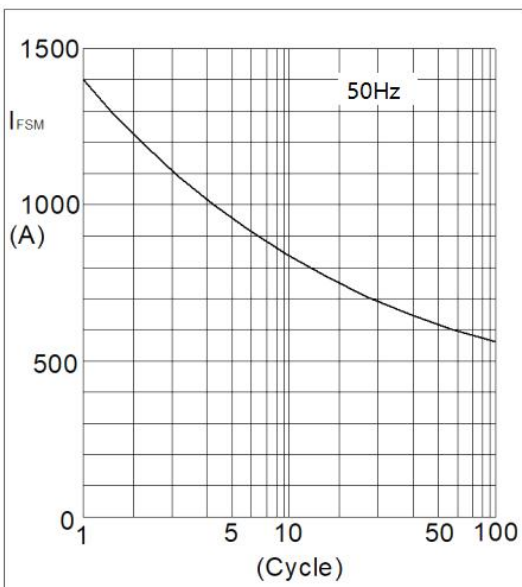
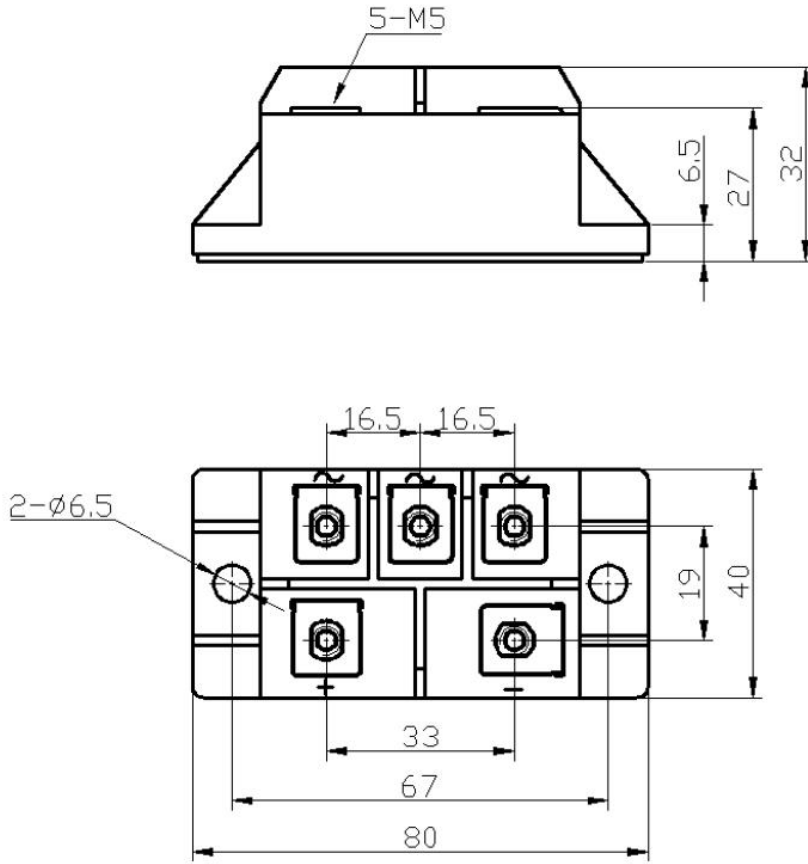

Fig5. Max Non-Repetitive Forward Surge Current

Package Outline Information

CASE: M15



Dimensions in mm

***IMPORTANT INFORMATION AND WARNINGS**

The specifications of Zhejiang Guchi Electronics Co., Ltd. products may not be considered as a guarantee or assurance of product characteristics. The specifications describe only the usual characteristics of products expected in typical applications, which may still vary depending on the specific application. Therefore, products must be tested for the respective application in advance, and application adjustments may be necessary. The user of our products is responsible for the safety of their applications embedding our products and must take adequate safety measures to prevent the applications from causing physical injury, fire, or other problems if any of our products become faulty. The user is responsible for ensuring that the application design complies with all applicable laws, regulations, norms, and standards. Except as otherwise explicitly approved by Zhejiang Guchi Electronics Co., Ltd. in a written document signed by authorized representatives, our products may not be used in any applications where a failure of the product or any consequences of the use thereof can reasonably be expected to result in personal injury.

No representation or warranty is given, and no liability is assumed with respect to the accuracy, completeness, and/or use of any information herein, including without limitation, warranties of non-infringement of intellectual property rights of any third party. Zhejiang Guchi Electronics Co., Ltd. does not assume any liability arising out of the applications or use of any product; neither does it convey any license under its patent rights, copyrights, trade secrets, or other intellectual property rights, nor the rights of others. We make no representation or warranty of non-infringement or alleged non-infringement of intellectual property rights of any third party which may arise from applications. Due to technical requirements, our products may contain dangerous substances. For information on the types in question, please contact the nearest sales office. This document supersedes and replaces all information previously supplied and may be superseded by updates. We reserve the right to make changes.